

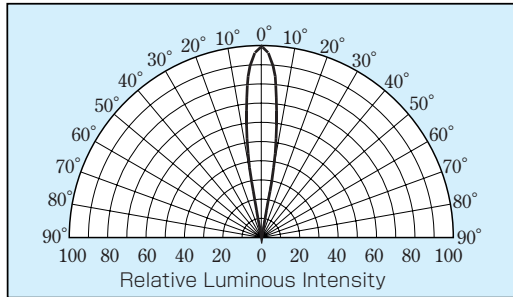

Characters

- Viewing angle 15° \*Reference
- No stand-off type

Directive Characteristics (Ta=25°C)



Package Outlines (Unit:mm)

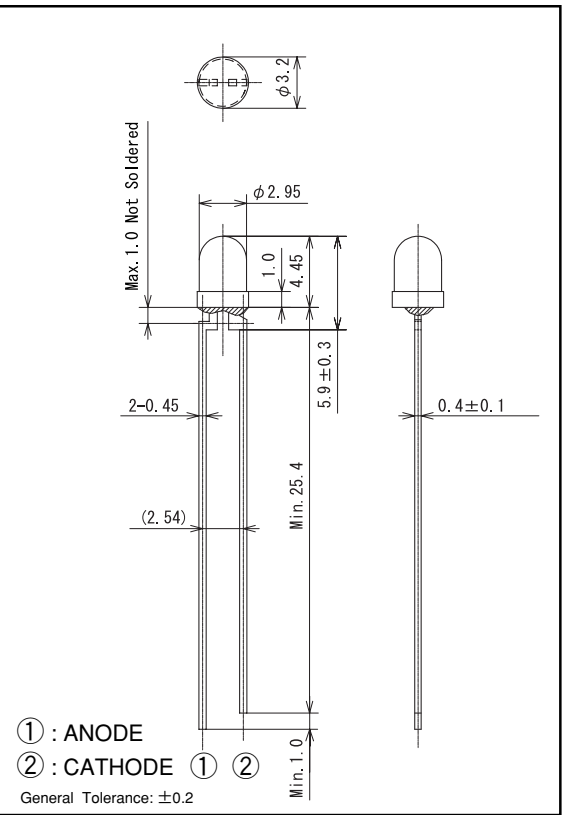

Round Lamp/ Mono

Absolute Maximum Ratings (Ta=25°C)

Item	Symbol	Value	Unit
Power Dissipation	P <sub>D</sub>	120	mW
DC Forward Current	I <sub>F</sub>	30	mA
Pulsed Forward Current	I <sub>FP</sub>	100★ <sup>1</sup>	mA
Reverse Voltage	V <sub>R</sub>	5	V
Operating Temperature	T <sub>opr</sub>	-30~ +80	°C
Storage Temperature	T <sub>stg</sub>	-40~+100	°C

★<sup>1</sup> Duty 1/10 Pulse Width 10 ms.

Electrical and Optical Characteristics (Ta=25°C)

Part No.★ <sup>2</sup>	Luminous Intensity (mcd)★ <sup>3</sup>			Forward Voltage (V)			Reverse Current (μA)		Wavelength Characteristics (nm)			
	Typ.	Min.	I <sub>F</sub> (mA)	Typ.	Max.	I <sub>F</sub> (mA)	Max.	V <sub>R</sub> (V)	λ <sub>D</sub> Min.	λ <sub>D</sub> Max.	Δλ Typ.	I <sub>F</sub> (mA)
E1L31-3B0A*-02	1300	650	20	3.4	3.9	20	2	5	465	475	25	20
E1L31-AG0A*-02	4200	3200	20	3.3	3.9	20	2	5	520	540	35	20
E1L31-AC1A*-02	1900	1500	20	3.3	3.9	20	2	5	(495)★ <sup>4</sup> (505)★ <sup>4</sup>	(505)★ <sup>4</sup> (510)★ <sup>4</sup>	35	20

★<sup>2</sup> See table for Luminous Intensity Ranks.

★<sup>3</sup> Axial Direction (Luminous Intensity)

★<sup>4</sup> Products are sorted by wavelength.

Luminous Intensity Ranks (Ta=25°C)

Luminous Intensity (mcd)					
BLUE®		GREEN®		BLUISH-GREEN®	
Rank		Rank		Rank	
3	650~ 850	5	3200~4200	D · M	1500~1900
4	850~1100	6	4200~5500	E · N	1900~2500
5	1100~1500			F · P	2500~3200
6	1500~1900			G · Q	3200~4200

(I<sub>F</sub>=20mA)

★Please contact sales person, if you request to designate Luminous Intensity Ranks.

Package

Bulk ..... 200pieces/bag (Code No.2)  
 Taping ..... 3000pieces/reel (Code No.7)  
 (example: 200 pieces/bag → E1L31-3B0A2-02)

★Please use the Part Number above for your order.

Precautions in handling

· When soldering, leave 1.6 mm of minimum clearance between the resin and the soldering point.

Taping Outline Dimensions (Unit:mm)

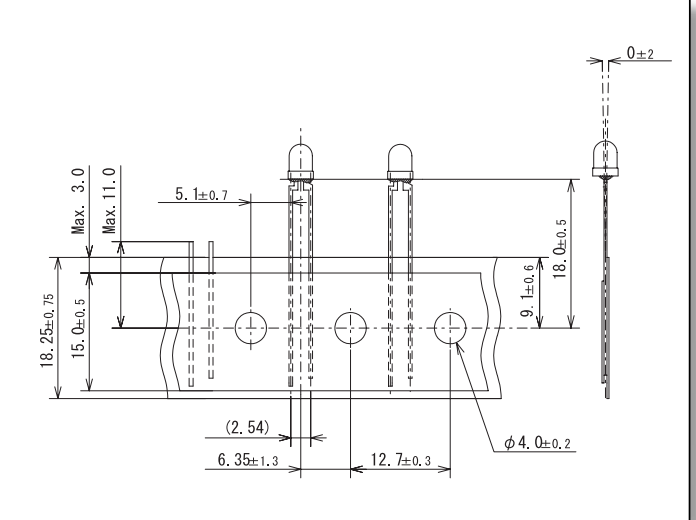

## Typical Characteristics

\* The data shows typical value.

Round Lamp/ Mono

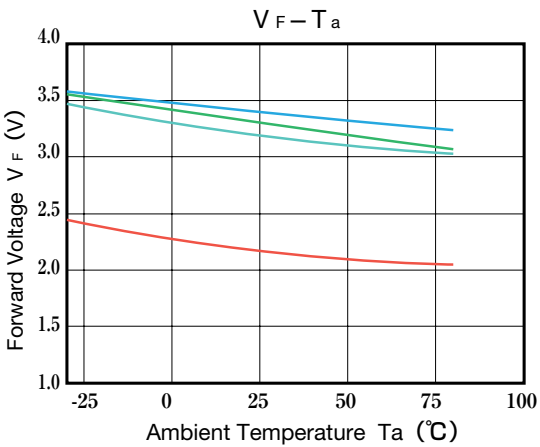
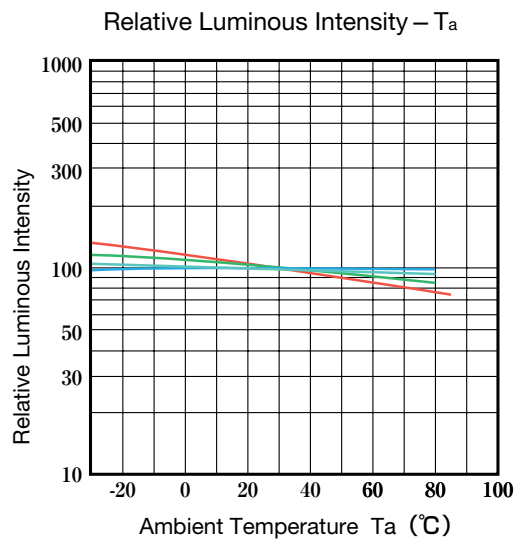
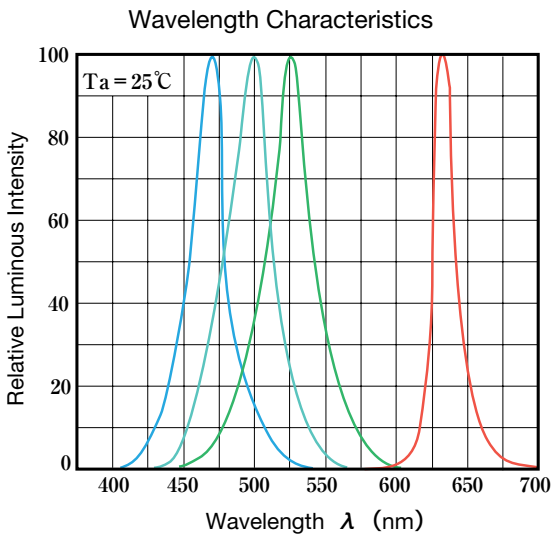
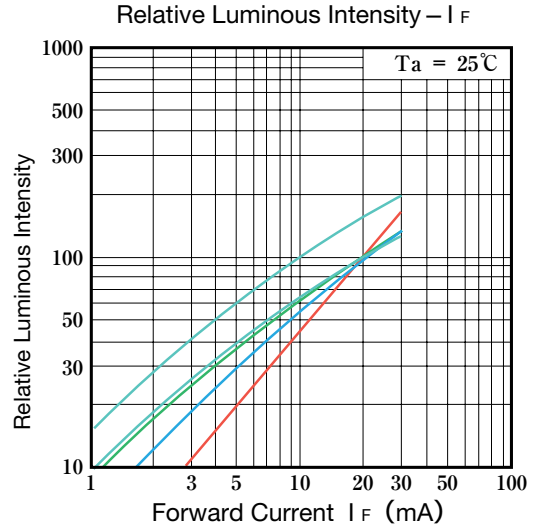
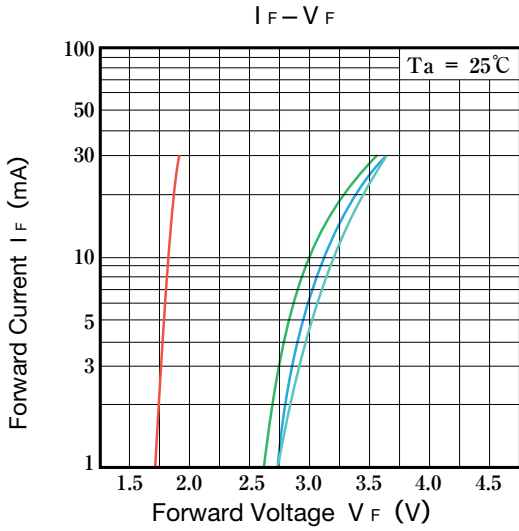

## Allowable Value

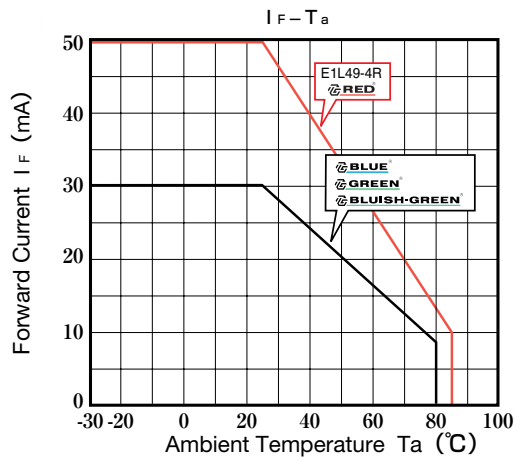



PRECAUTIONS IN USE

- ① **Soldering Conditions**
  - When soldering, leave minimum clearance between the resin and the soldering point.
  - Maximum allowable soldering conditions are:
    - Solder dipping : 260 degrees C max., 5 seconds max., one time.
    - Soldering iron : 350 degrees C max., 5 seconds max., one time, power 40W max.
  - Contact between molten solder and the resin must be avoided.
  - Adjusting the soldered position after soldering must be avoided.
  - In soldering, do not put any stress to the lead frame, particularly when heated.
  - When other SMD parts on the same circuit board and adhesive is to be cured, maximum allowable conditions are :
    - 120 degrees C max., 60 seconds max.
- ② **Lead forming and cut**
  - Lead forming must be done below the tie bar cutting position.
  - When forming a lead, do not stress the resin case.
  - Cutting lead forming must be done before soldering.
  - Cutting the lead frame at high temperature may cause problems. Cut the lead frame at room temperature.
- ③ **Assembly**
  - Do not put any stress to the lead frame while assembling.
  - When mounting Products onto boards such as printed wired board, the pitch between the two holes of such boards must be the pitch of the Products.
- ④ **Static Electricity**
  - These products are so sensitive to static electricity charge that users are required to handle with care. Particularly if an over-current and over-voltage which exceeds the Absolute Maximum Rating of Products is applied, the overflow in energy may cause damage to, or possibly result in electrical destruction of, the Products. Customer is requested to adequate countermeasures against static electricity charge and surge when handling Products.
  - A protection device should be installed in the LED driving circuit, which does not exceed the max. rating for surge current during on/off switching.
  - Proper grounding of Products (via  $1M\Omega$ ), use of conductive mat, semiconductive working uniform and shoes, and semiconductive containers are considered to be effective as countermeasures against static electricity and surge.
  - When the electrified product touches the low resistance part such as the metal face, there is a high possibility that it may be charged due to radical electric discharge.
    - When grinding, use of resisting element such as conductive mat is effective for parts where the product directly touches.
  - A tip of soldering iron is requested to be grounded. An ionizer should also be installed where risk of static generation is high.
  - If the countermeasures mentioned above are implemented, LED can work well.
    - Users are required to confirm those countermeasures when problems are caused by static electricity.
- ⑤ **Safety Precautions**
  - Users are requested to comply with the laws and public regulations concerning safety.
  - The light output of the Products may cause injuries to human eyes in circumstances where the Products are viewed directly for more than a few seconds.



## PRECAUTIONS IN USE

1

The products described in this brochure are intended only for standard applications or general electronic equipment such as office equipment, communications, and electronic instrumentation and household electrical appliances.

When they are used for transport equipment, disaster prevention and crime prevention equipment as well as other safety devices calling for high reliability and safety, users are required to pay particular heed to the safety design of the equipment as a whole in terms of fail-safe design and redundant design to maintain the reliability and safety of the equipment.

Consult Toyoda Gosei's staff in advance for special applications such as aviation, spacecraft, heating equipment and life-sustaining equipment which require exceptionally high reliability and safety and if their failure or malfunction may threaten human lives or may be detrimental to human bodies.

It is to be understood that the seller shall not be held responsible for any damage incurred as a result of using the product for the purpose which is not the standard the seller has intended to be used for, unless the seller agrees to the non-standard use in writing.

2

Users are requested to comply with the laws and public regulations concerning safety.

3

In the event the products which are to be used are in mass production, the execution of written specifications or purchase agreement between the seller and the customer is required.

The seller shall bear no responsibility for any damages or injury that are caused by customers' usage of the products without the execution of such specification or purchase agreement.

4

The detail of tolerance for Electrical/Optical characteristics can be found on the execution of written specifications.