

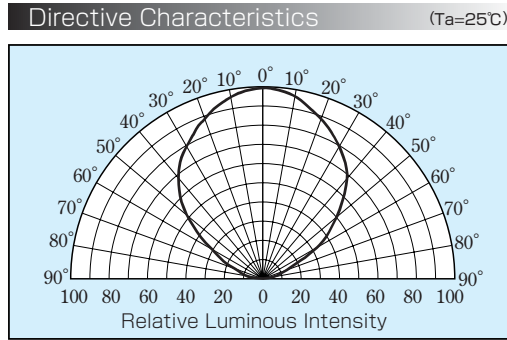

- Characters**
- $\phi 5$ Can type
 - Flat window type
 - Viewing angle 100° *Reference
 - ESD Protected [$\pm 1\text{kV}$, 1time, (200pF 0 Ω)]

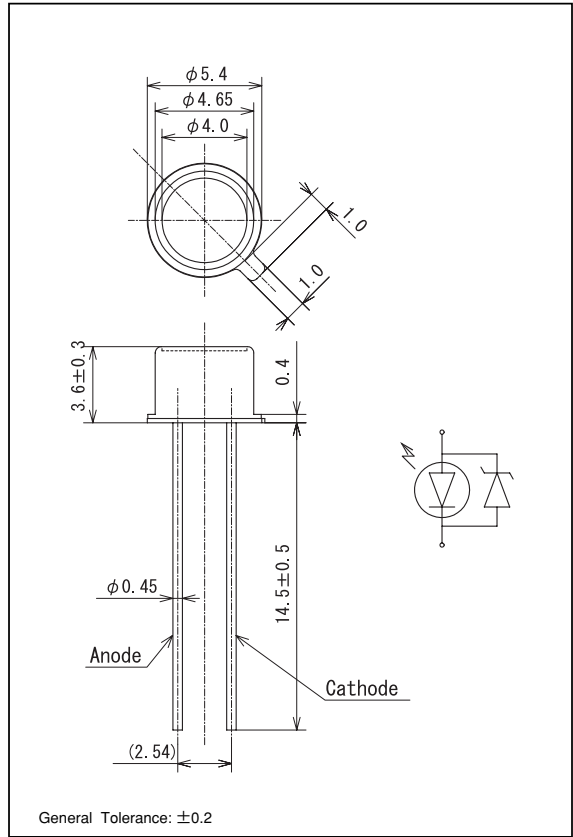

Package Outlines (Unit:mm)



Absolute Maximum Ratings (Ta=25°C)

Item	Symbol	Value	Unit
Power Dissipation	P_D	120	mW
DC Forward Current	I_F	30	mA
Pulsed Forward Current	I_{FP}	100 \star^1	mA
Reverse Current	I_{RDC}	100 \blacktriangle	mA
Operating Temperature	T_{opr}	$-30 \sim +80$	$^\circ\text{C}$
Storage Temperature	T_{stg}	$-40 \sim +100$	$^\circ\text{C}$

\star^1 Duty 1/10 Pulse Width 10 ms. \blacktriangle This Rating is for Zener Diode.

Electrical and Optical Characteristics Ranks (Ta=25°C)

Part No. \star^2	Optical Power (mW)			Forward Voltage 1 (V)			Forward Voltage 2 (V)		Wavelength Characteristics (nm)			
	Typ.	Min.	I_F (mA)	Typ.	Max.	I_F (mA)	Min.	I_F (μA)	λ_P Min.	λ_P Max. \star^3	$\Delta\lambda$ Typ.	I_F (mA)
E1L5M-3POC2-01	—	1.5	20	—	4.2	20	2.5	10	374	383 \star^3	18	20
									383	392 \star^3		

\star^2 See table for optical power Ranks. \star^3 Devices are sorted by 9 nm wavelength ranges.

Optical Power · Wavelength (Ta=25°C)

Luminous Intensity (mW)		
Rank		PURPLE Hi™
374~383	383~392	
2--1	2--2	1.5~ 2.3
3--1	3--2	2.3~ 3.5
4--1	4--2	3.5~ 5.2
5--1	5--2	5.2~ 7.8
6--1	6--2	7.8~12.0

($I_F=20\text{mA}$)

\star Please contact sales person, if you request to designate Luminous Intensity Ranks.

Package

Bulk 200pieces/bag

\star Please use the Part Number above for your order.

Precautions in handling

· When soldering, leave 4 mm of minimum clearance between the resin and the soldering point.

Caution

\blacksquare This product emits ultraviolet rays, which may damage the retina and the other organ.

Precautions in use below shall be complied especially when unshielded eye could be confronted.

- ① Do not look directly at the LED when it is operating.
- ② Direct radiation shall be shielded with protective glasses and clothes.
- ③ Keep small children apart from the LED.



Typical Characteristics

* The data shows typical value.

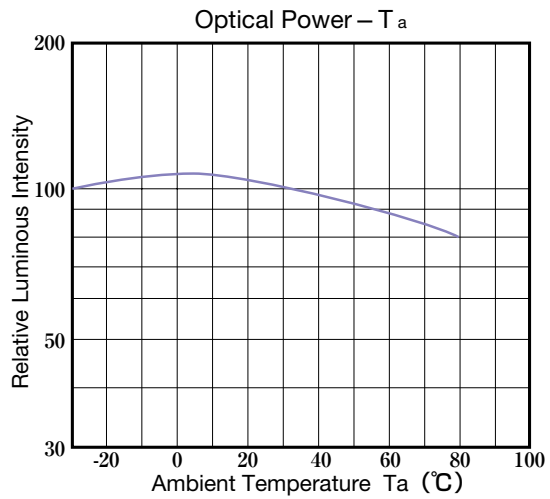
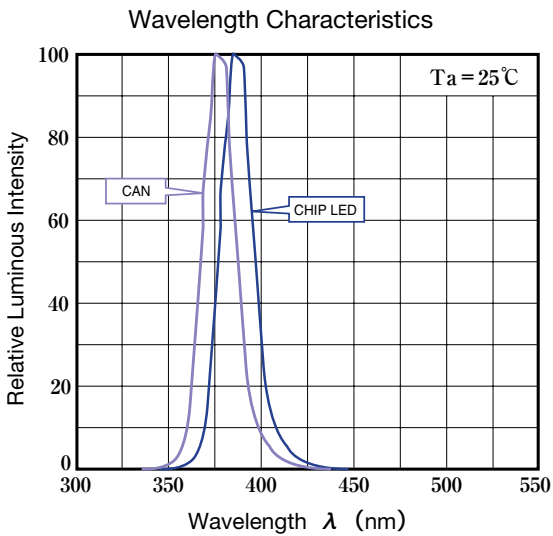
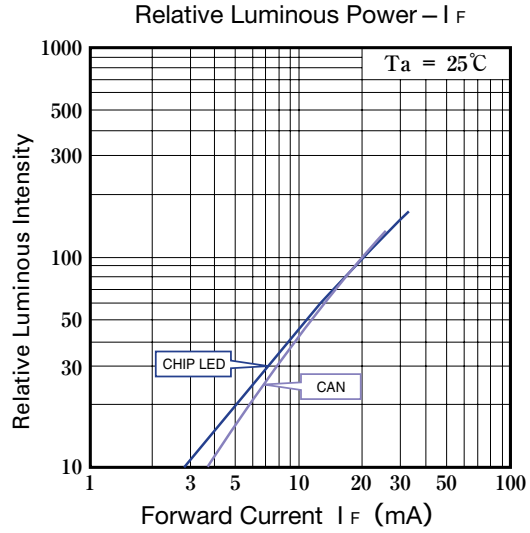
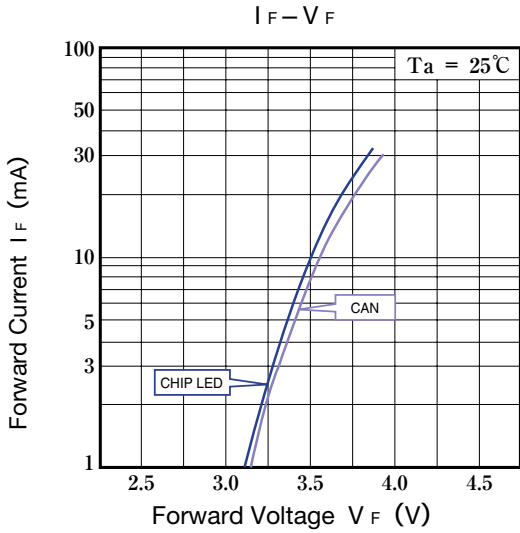

Allowable Value

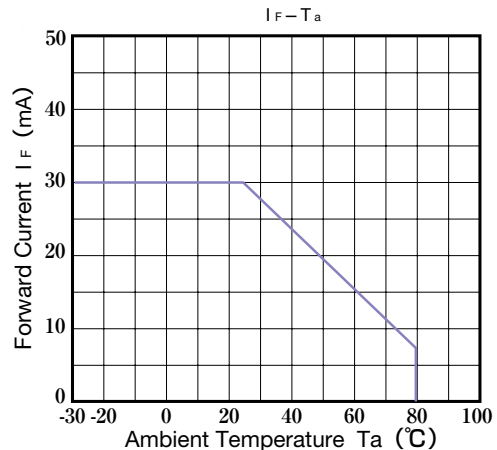
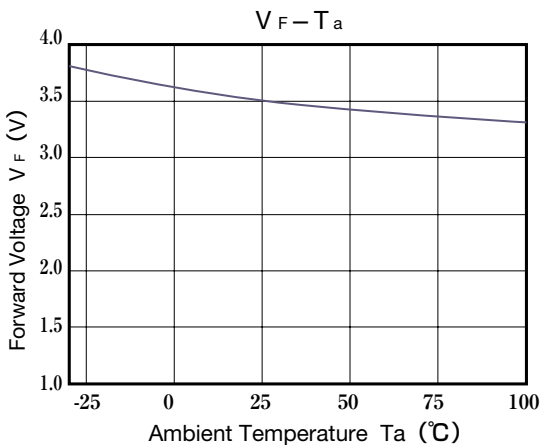

Purple LED



PRECAUTIONS IN USE

- ① **Soldering Conditions**
 - [E1S19-0P]
When soldering chip LEDs, it is likely that the humidity within the resin may disturb the adherence of junction. The disturbance could influence the optical characteristics of products.
 - Do not stress resin portion under the high temperature in high heat environment.
 - Please place the Products away from other materials when surface mounting and Delivery handling.
 - Maximum allowable soldering conditions are:
Reflow solder : 240 degrees C max., 5seconds max., once.Pre-heat is 150 degrees C max., 2minutes max.
Soldering iron : 300 degrees C max., 5 seconds max., once.
 - [E1L5M-3P, E1L5M-4P]
 - When soldering, leave 4mm between the metal case and the soldering point.
 - Maximum allowable soldering conditions are:
Solder dipping : 260 degrees C max., 5seconds max., once.
Soldering iron : 350 degrees C max., 5seconds max., once, power 40 W max.
 - Contact between molten solder and the resin must be avoided.
 - Correcting the soldered position after soldering must be avoided.
 - In soldering, do not apply any stress to the lead , particularly when heated.
 - When other SMD parts in the same circuit board and adhesive is to be cured, maximum allowable conditions are:120 degrees C max., 60 seconds max.
- ② **Lead forming and cut**
 - [E1L5M-3P, E1L5M-4P]
 - When forming a lead, do not stress the metal case.
 - Lead forming must be done before soldering.
 - Cutting the lead at high temperature may result in personal injury. Cut the lead at room temperature.
 - [E1L5M-3P, E1L5M-4P]
 - Do not apply any stress to the lead while assembling.
 - When mounting Products onto boards such as printed wired board, the pitch between the two holes of such boards must match the pitch of the Products.
- ③ **Assembly**
 - [E1L5M-3P, E1L5M-4P]
 - Do not apply any stress to the lead while assembling.
 - When mounting Products onto boards such as printed wired board, the pitch between the two holes of such boards must match the pitch of the Products.
- ④ **Storage**
 - [E1S19-0P]
 - Use within 7 days after opening the sealed bag.
 - After opening the bag once, fold the opening firmly and keep it in a dry area.
- ⑤ **Baking**
 - [E1S19-0P]
 - If the Product packed in a package is stored over 6 months, or if it passes more than 15 days after package is opened, it is requested to make baking per following conditions.
Reel one : 60 degrees C × 12 hours or more
Loose one : 100 degrees C × 45 minutes or more,120 degrees C × 15 minutes or more
- ⑥ **Cleaning**
 - Do not use organic solvents such as acetone. Organic solvents will damage the surface of the chip.
- ⑦ **Static Electricity**
 - These products are so sensitive to static electricity charge that users are required to handle with care. Particularly if an over-current and over-voltage which exceeds the Absolute Maximum Rating of Products is applied, the overflow in energy may cause damage to, or possibly result in electrical destruction of, the Products. Customer is requested to adequate countermeasures against static electricity charge and surge when handling Products.
 - A protection device should be installed in the LED driving circuit, which does not exceed the max. rating for surge current during on/off switching.
 - Proper grounding of Products (via 1MΩ), use of conductive mat, semiconductive working uniform and shoes, and semiconductive containers are considered to be effective as countermeasures against static electricity and surge.
 - When the electrified product touches the low resistance part such as the metal face, there is a high possibility that it may be charged due to radical electric discharge.
 - When grinding, use of resisting element such as conductive mat is effective for parts where the product directly touches.
 - A tip of soldering iron is requested to be grounded. An ionizer should also be installed where risk of static generation is high.
 - If the countermeasures mentioned above are implemented, LED can work well.
Users are required to confirm those countermeasures when problems are caused by static electricity.
- ⑧ **Safety Precautions**
 - This product emits ultraviolet rays, which may damage the retina and the other organ.
 - Precautions in use below shall be complied especially when unshielded eye could be confronted.
 - ① Do not look directly at the LED when it is operating.
 - ② Direct radiation shall be shielded with protective glasses and clothes.
 - ③ Keep small children apart from the LED.



PRECAUTIONS IN USE

1

The products described in this brochure are intended only for standard applications or general electronic equipment such as office equipment, communications, and electronic instrumentation and household electrical appliances.

When they are used for transport equipment, disaster prevention and crime prevention equipment as well as other safety devices calling for high reliability and safety, users are required to pay particular heed to the safety design of the equipment as a whole in terms of fail-safe design and redundant design to maintain the reliability and safety of the equipment.

Consult Toyoda Gosei's staff in advance for special applications such as aviation, spacecraft, heating equipment and life-sustaining equipment which require exceptionally high reliability and safety and if their failure or malfunction may threaten human lives or may be detrimental to human bodies.

It is to be understood that the seller shall not be held responsible for any damage incurred as a result of using the product for the purpose which is not the standard the seller has intended to be used for, unless the seller agrees to the non-standard use in writing.

2

Users are requested to comply with the laws and public regulations concerning safety.

3

In the event the products which are to be used are in mass production, the execution of written specifications or purchase agreement between the seller and the customer is required.

The seller shall bear no responsibility for any damages or injury that are caused by customers' usage of the products without the execution of such specification or purchase agreement.

4

The detail of tolerance for Electrical/Optical characteristics can be found on the execution of written specifications.